

TAURUS swing top bin

Taurus swing top bin has a Stainless Steel body. The bin has a top opening to empty it. A inner Galvanised steel container is present to hold the waste bag.

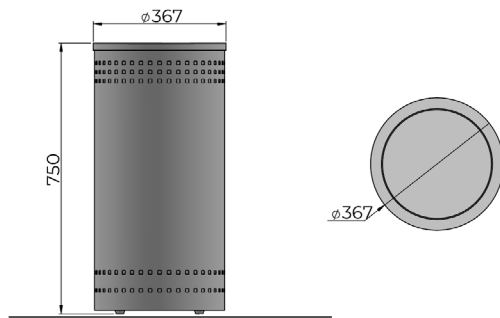

DIMENSIONS



Free standing
50 L



SCAN TO
VIEW IN AR

MATERIAL AND FINISH

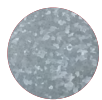

BODY, LID
Stainless Steel / Steel
Brush Finish / Powder Coating

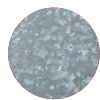

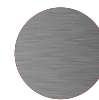

LINER
Steel
Galvanised



ACCESSORIES
Stainless Steel

STANDARD COLOURS

-  RAL 1013 Pearl White
-  RAL 7016 Anthracite Grey
-  RAL 9005 Jet Black

FINISH - POWDER COATING

- Semi - gloss
- Matt
- Texture

ADD-ONS

Signage / Logo

[Standard Graphics \(click to view\)](#)

WARRANTY

[Warranty document \(click to view\)](#)

CERTIFICATIONS

