

TAURUS cycle track bin

Taurus cycle track bin is made of Mild steel with Powder Coated finish in Zinc rich primer. The bin has a top opening to empty the waste. It can be customised to have dual colours. It has colour coded openings to dispose recyclable waste. It contains a Galvanised Steel inner container to hold waste bag.

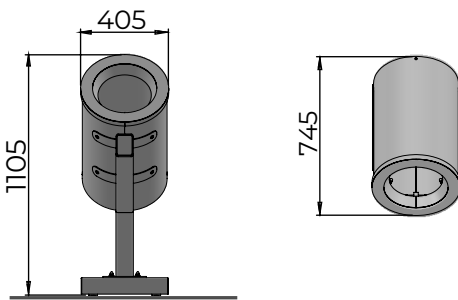

DIMENSIONS



Free standing
60 L



SCAN TO
VIEW IN AR

MATERIAL AND FINISH

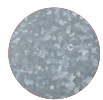

BODY, LID
Steel
Powder Coating

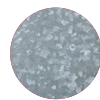

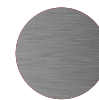

LINER
Steel
Galvanised



ACCESSORIES
Stainless Steel

STANDARD COLOURS

-  RAL 1013 Pearl White
-  RAL 7016 Anthracite Grey
-  RAL 9005 Jet Black

FINISH - POWDER COATING

- Semi - gloss
- Matt
- Texture

ADD-ONS

Signage / Logo

Lock (SS 316)

[Standard Graphics \(click to view\)](#)

WARRANTY

[Warranty document \(click to view\)](#)

CERTIFICATIONS

