

# TAURUS TOP litter bin

Taurus top is made of Mild steel with Powder Coated finish in Zinc rich primer. The bin has a top opening to empty the waste. It can be customised to have dual colours. It contains a Galvanised Steel inner containers to hold waste bags.

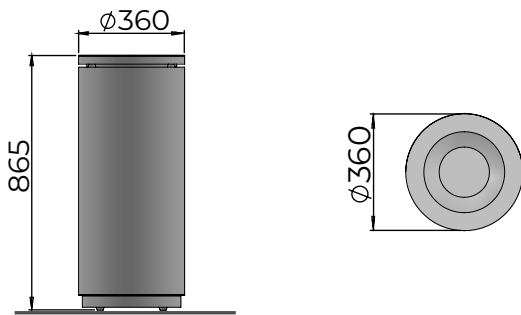

## DIMENSIONS



Free standing / Surface Fixed  
40 L

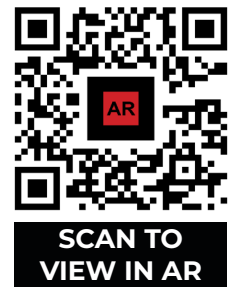

SCAN TO  
VIEW IN AR

## MATERIAL AND FINISH

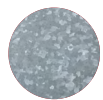

**BODY, LID**  
Steel  
Powder Coating

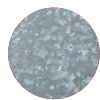

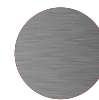

**LINER**  
Steel  
Galvanised



**ACCESSORIES**  
Stainless Steel

## STANDARD COLOURS

-  RAL 1013 Pearl White
-  RAL 7016 Anthracite Grey
-  RAL 9005 Jet Black

## FINISH - POWDER COATING

- Semi - gloss
- Matt
- Texture

## ADD-ONS

Signage / Logo

Lock (SS 316)

[Standard Graphics](#) (click to view)

## WARRANTY

[Warranty document](#) (click to view)

## CERTIFICATIONS

