

TAURUS II recycling bin

Taurus II has a Mild steel body with Powder Coated finish in Zinc rich primer. The bin has a top opening to empty it. The bin comes in dual colour with SS 316 accessories. Two inner Galvanised steel containers are present to hold the waste bag.

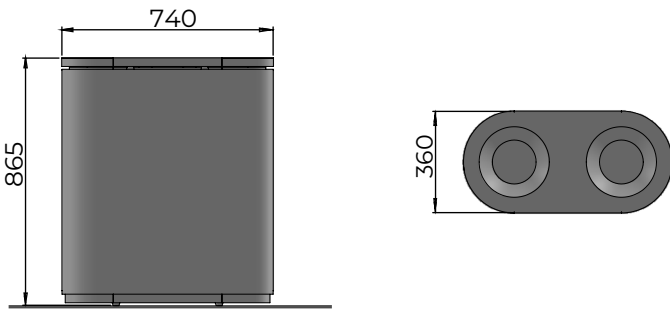

DIMENSIONS



Free standing / Surface Fixed
2 x 45 L



SCAN TO
VIEW IN AR

MATERIAL AND FINISH

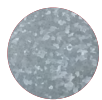

BODY, LID
Steel
Powder Coating

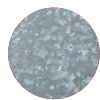

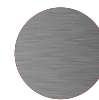

LINER
Steel
Galvanised



ACCESSORIES
Stainless Steel

STANDARD COLOURS

-  RAL 1013 Pearl White
-  RAL 7016 Anthracite Grey
-  RAL 9005 Jet Black

FINISH - POWDER COATING

- Semi - gloss
- Matt
- Texture

ADD-ONS

Signage / Logo

Lock (SS 316)

[Standard Graphics](#) (click to view)

WARRANTY

[Warranty document](#) (click to view)

CERTIFICATIONS

