

KAVA III recycling bin

Kava III is made of Mild steel body, lid & skirting with Powder Coated finish in Zinc rich primer. The bin has a top opening to empty the waste. It comes in dual colour and contains three galvanised steel inner containers to hold waste bags.

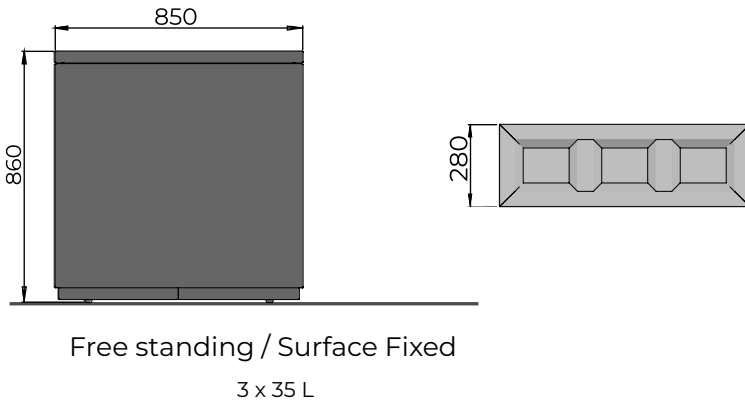

DIMENSIONS



MATERIAL AND FINISH

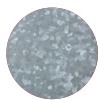

BODY, LID
Steel
Powder Coating

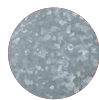

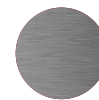

LINER
Steel
Galvanised



ACCESSORIES
Stainless Steel

STANDARD COLOURS

-  RAL 1013 Pearl White
-  RAL 7016 Anthracite Grey
-  RAL 9005 Jet Black

FINISH - POWDER COATING

- Semi - gloss
- Matt
- Texture

ADD-ONS

Signage / Logo

Lock (SS 316)

[Standard Graphics \(click to view\)](#)

WARRANTY

[Warranty document \(click to view\)](#)

CERTIFICATIONS

